

THE PROPERTY OF THE DRAWING IS ESTABLISHED BY LAW. IT IS FORBIDDEN TO PRODUCE OR SHOW IT TO THIRD PART. WITHOUT A WRITTEN AGREEMENT.

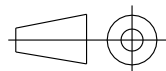
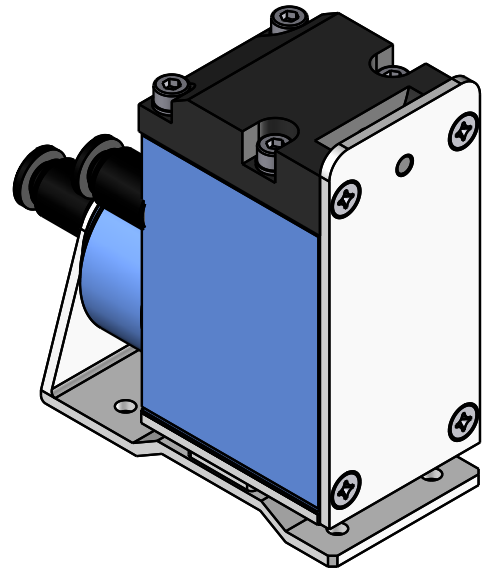
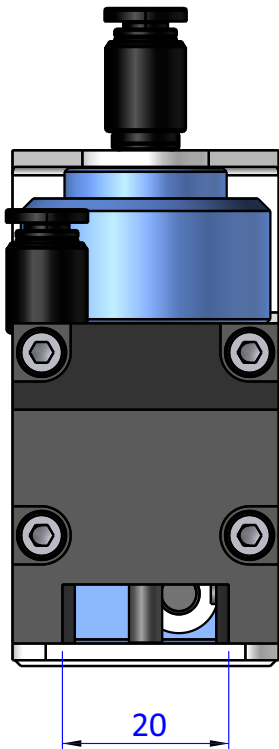
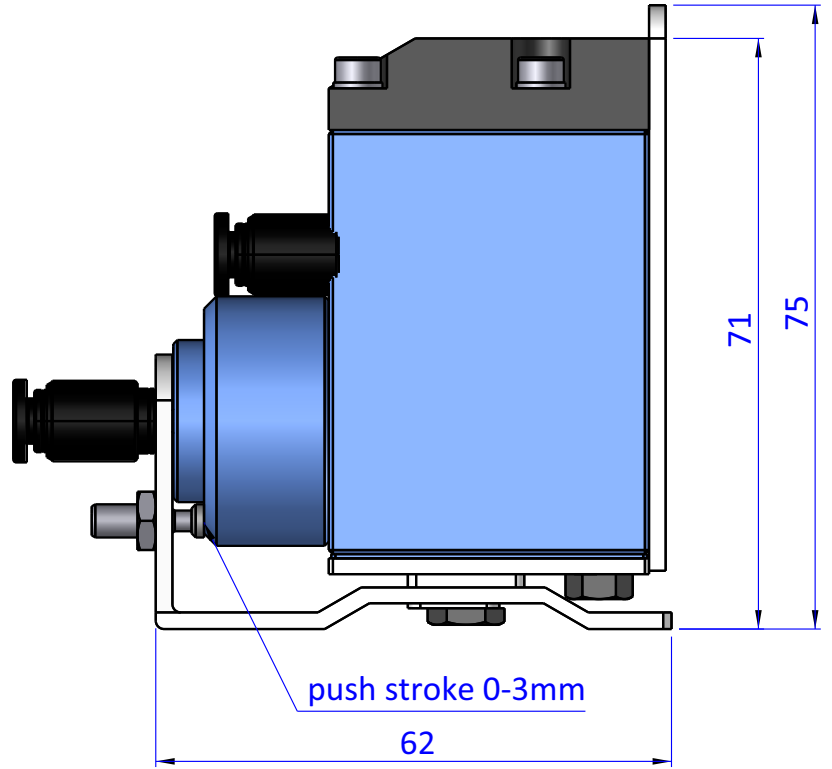
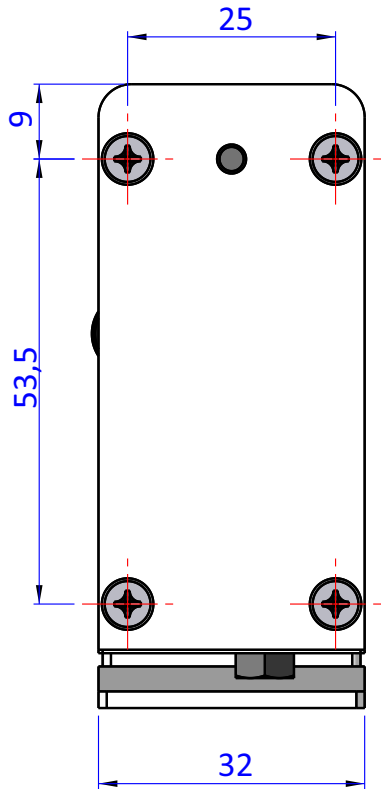

DESIGNED FROM	REVIEW
FPS Automation	A

DATE	WEIGHT
30/10/2020	0,325kg

CODE
VES.GTNT05R4

Format A4

UNI 936-76

GENERAL TOLERANCE

UNI - ISO 2768

CLASSE f

DESCRIPTION

VES.GTNT05R4